

ESPA

THE EVOLVED SECONDARY PAYLOAD ADAPTER



ESPA mounts to the standard NSSL (formerly EELV) interface bolt pattern (Atlas V, Falcon 9, Delta IV, OmegA, Vulcan, New Glenn) and is a drop-in component in the launch stack. Small payloads mount to ESPA ports featuring either a Ø15-inch bolt circle with 24 fasteners or a 4-point mount with pads at each corner of a 15-inch square; both of these interfaces have become small satellite standards.

ESPA is qualified to carry 567 lbs (257 kg), and a Heavy interface (with Ø5/16" fastener hardware) has been introduced with a capacity of 991 lbs (450 kg). All small satellite mass capabilities require the center of gravity (CG) to be within 20 inches (50.8 cm) of the ESPA port surface. Alternative configurations can be accommodated.

ESPA GRANDE

ESPA Grande is a more capable version of ESPA with Ø24-inch ports; the ring height is typically 42 inches. The Ø24-inch port has been qualified by test to carry small satellites up to 1543 lb (700 kg).

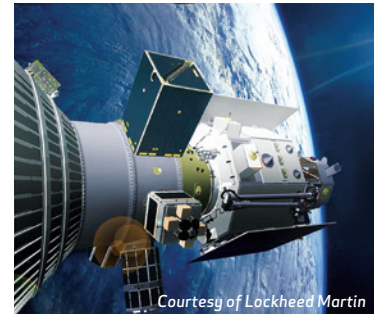

Courtesy of Lockheed Martin

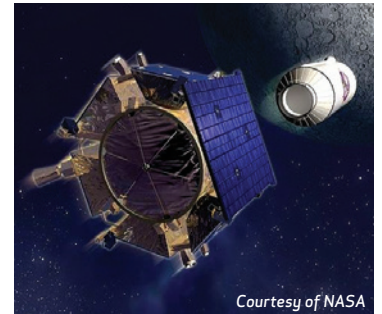

Courtesy of NASA



Courtesy of ORBCOMM & Sierra Nevada Corp.

ESPA IS ADAPTABLE TO UNIQUE MISSION REQUIREMENTS

- The Air Force's STP-1 mission delivered multiple small satellites on an Atlas V.
- NASA's Lunar Crater Observation and Sensing Satellite (LCROSS): ESPA was the spacecraft hub for the LCROSS shepherding satellite in 2009.
- ORBCOMM Generation 2 (OG2) launched stacks of two and three ESPA Grandes on two different Falcon 9 missions and in total deployed 17 satellites. (2014-15)
- AFRL's ESPA Augmented Geostationary Laboratory Experiment (EAGLE) used ESPA as the primary structure of a free-flyer satellite in 2018 and was the prototype for on-going Long Duration Propulsive ESPA (LDPE) programs, renamed ROOSTER.
- AFRL's DSX mission, launched on Falcon Heavy in 2019, is in Medium Earth Orbit, also demonstrating ESPA's capability as the structural hub of a satellite.
- Spaceflight Industries' SSO-A mission, launched on Falcon 9 in 2019, used ESPA (with SoftRide vibration isolation) to carry multiple small spacecraft in a stack of various adapters showing the 'stackable' nature of this type of system.

ESPA uses thru holes on the ports but they can be tapped holes if required. ESPA minimum height is determined by the port size, e.g., 24-inch ports correspond to a 32-inch height minimum, but 42-inch is typical for ESPA Grande.

Tested ESPA capacity assumes the use of load factors based on the ESPA Mass Acceleration Curve (MAC). The ESPA MAC is described in detail in Moog's ESPA User's Guide, available on-line at:

https://www.moog.com/content/dam/moog/literature/Space_Defense/spaceliterature/structures/moog-espa-users-guide-datasheet.pdf

SPECIFICATIONS

| | ESPA P/N | Port Count | Port ϕ | Ring Height | Port Payload Capacity | ESPA Mass | Port Interface Bolt Size |
|----------------|----------|------------|-------------|-------------|-----------------------|-----------|--------------------------|
| Standard ESPA | 6-15-24 | 6 | 15" | 24" | 257 kg* | 136 kg | 1/4" Bolts |
| ESPA Heavy | | | | | 450 kg* | | 5/16" Bolts |
| ESPA Grande | 4-24-42 | 4 | 24" | 42" | 700 kg* | 211 kg | 1/4" Bolts** |
| Stretched ESPA | 4-24-60 | | | 60" | | | |

* Capacities require CG at 50.8cm (20"), and decrease to 220 kg, 322 kg, and 465 kg if using heritage ESPA load factors.

** ESPA Grande is qualified with 1/4" or 5/16" bolts, larger bolts are recommended (but not required) for payloads above 465 kg

OTHER VARIANTS

ESPA is versatile and can be easily modified, in many cases with no impact to the qualification status. Port size and quantity can be "mixed and matched" to accommodate a variety of payloads. A common modification is five 24-inch ports on an ESPA Grande. Other port sizes such as 11.7-inch and 8-inch are possible. Examples include:

- Small Launch ESPA - ϕ 38.8-inch ring provides 8- or 15-inch ports for Minotaur family and other small launch vehicles. The SL-ESPA has a mass of 59 kg.
- ESPASTM - Custom ESPA for NGIS's ESPASTM product line. This ring has no circular ports but instead the ESPA 4-Point Mount (4PM) in six locations, and it has a mass of 113 kg (compared to 136 kg for the standard ESPA).

DIMENSIONS

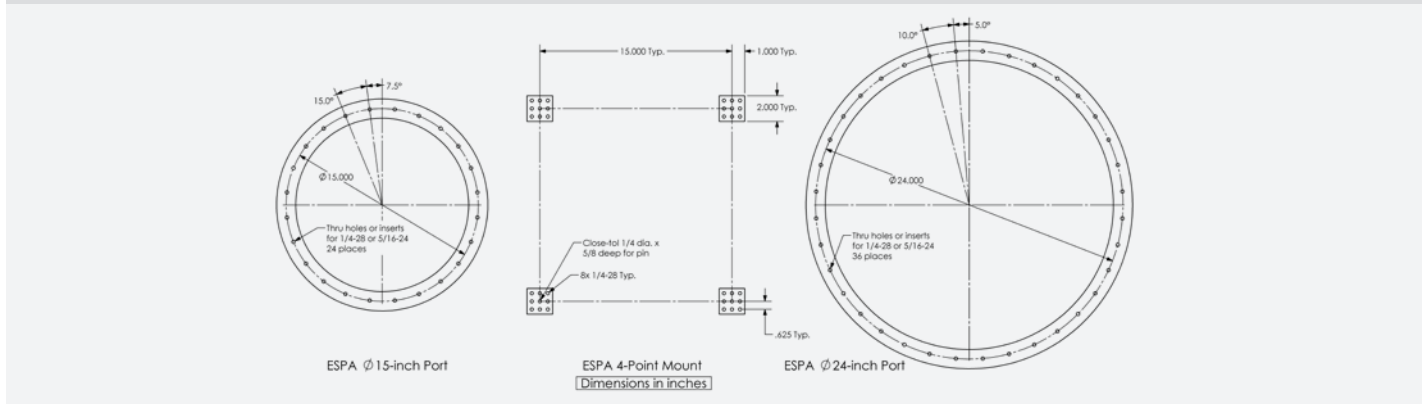

MOOG
SPACE AND DEFENSE GROUP

2581 Leghorn Street, Mountain View, CA 94043-1613 USA
+1.650.210.9000 Fax: +1.650.210.9001
www.moog.com/space



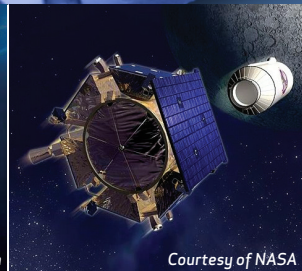
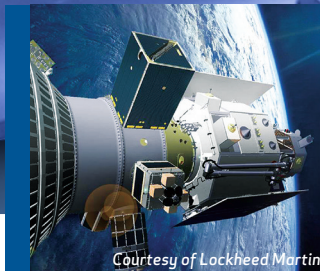
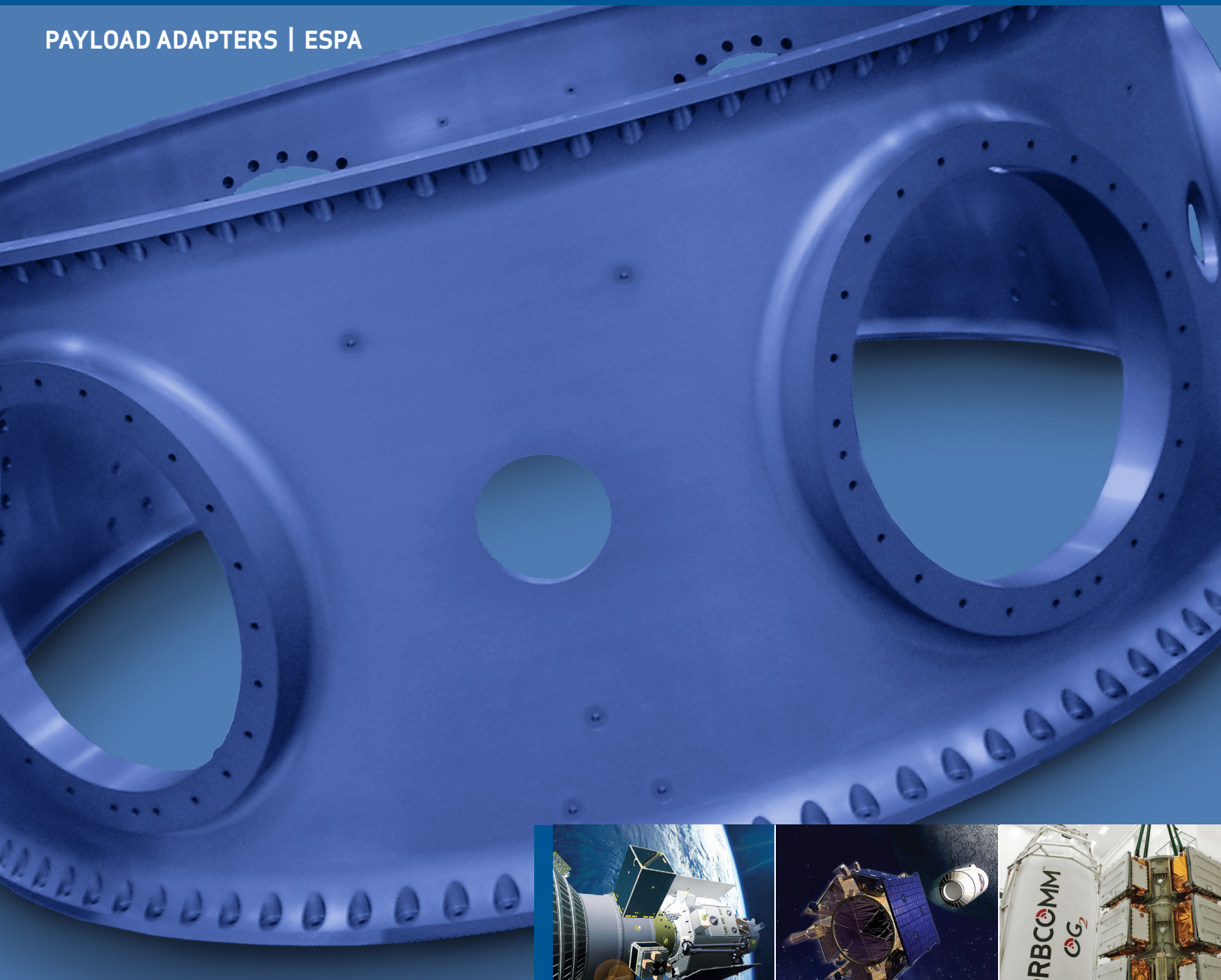

ESPA USER'S GUIDE

THE EELV SECONDARY PAYLOAD ADAPTER
NOVEMBER 2018

Contents

| | |
|---|----|
| 1. Introduction | 3 |
| 2. ESPA Overview | 4 |
| a. Capability | 5 |
| b. Nomenclature | 6 |
| c. Interfaces | 6 |
| d. Height | 6 |
| e. Mass | 7 |
| f. Baseline Configurations..... | 8 |
| 3. Interfaces..... | 9 |
| a. Type | 9 |
| b. Quantity | 11 |
| c. Fasteners..... | 11 |
| d. Load Capacity..... | 12 |
| e. Volume | 13 |
| f. Separation Systems..... | 15 |
| g. Summary..... | 16 |
| 4. Flight Environments | 18 |
| a. Quasi-Static Loads..... | 18 |
| b. Sinusoidal Vibration..... | 19 |
| c. Random Vibration | 19 |
| d. Acoustics..... | 20 |
| e. Shock..... | 21 |
| 5. Customization | 22 |
| 6. Moog Mission Support..... | 23 |
| 7. Frequently Asked Questions | 24 |
| 8. Contact Information..... | 25 |
| Appendix ESPA Flight Heritage and Document Revision History | 26 |

1. Introduction

The ESPA ring was developed as the Evolved Expendable Launch Vehicle (EELV) Secondary Payload Adapter to utilize excess launch capacity by mounting additional payloads below the primary payload. The objective was to reduce launch costs for the primary mission while enabling auxiliary payloads (APLs) and even tertiary payloads with minimal impact to the primary payload. The ESPA design, shown in Figure 1, replicates the EELV 62" (1575 mm) bolt circle so the ring can be inserted on the vehicle below the primary payload while providing six mounting ports for small satellites. Moog has expanded the definition of ESPA to include larger- and smaller-diameter rings, and to address the fact that some EELVs are no longer expendable; therefore we will gradually transition the ESPA family name to Evolved Secondary Payload Adapter, while maintaining traceability to the original ESPA structure design.

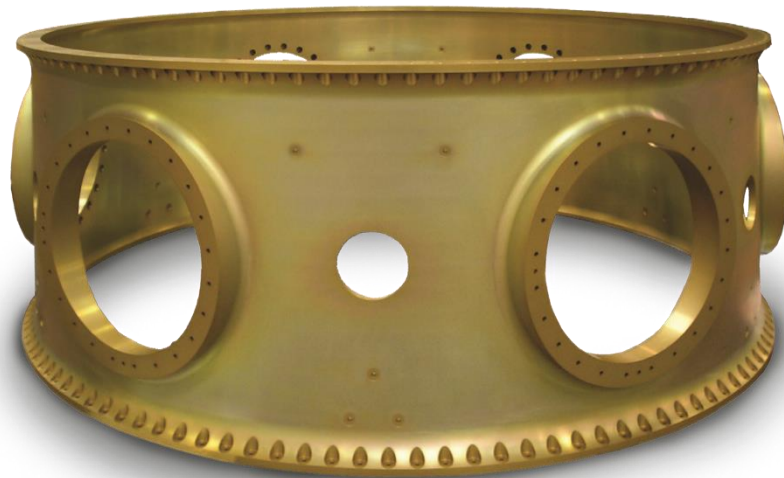

Figure 1. EELV Secondary Payload Adapter

In the mid-90s, the DoD Space Test Program (STP) of the Air Force Space and Missile Systems Center (SMC) identified large unused payload margins on the majority of EELV manifests, and advocated for a secondary payload capability. By 2002, a contractor team led by Moog (CSA Engineering at that time) engineers, working with the Space Vehicles Directorate of the Air Force Research Laboratory (AFRL/RV), developed and qualified ESPA for flight. Since then, ESPA has become an essential element of US small satellite launch infrastructure. This document provides information for mission planning and design using the ESPA.

2. ESPA Overview

The Moog ESPA is manufactured from a 7000-series aluminum ring forging. The original ESPA replicates the EELV standard interface, i.e., 62.01" (1575 mm) in diameter, with 120 evenly spaced fasteners, and allows a primary payload up to 17,000 pounds to be mounted on top of an ESPA without requiring any modifications. Variants of the original configuration have been developed for other launch vehicles. Satellites are mounted externally to the ESPA ring with a variety of port options, and features can be added for internal mounting or mission specific structure modifications.

In addition to providing accommodation for secondary payloads, the ESPA has been used on several missions as the structural body of a spacecraft itself. The ports of the ESPA enable the modular design of a medium class spacecraft that can still be launched as a secondary payload. Examples of this are the LCROSS and EAGLE missions.

The ESPA can also be stacked on top of itself multiple times, as illustrated in Figure 2. This enables the launching of dozens of auxiliary payloads at once for rapid constellation deployment or significant cost saving by sharing a ride with multiple other passengers. Ultimately the ESPA is a modular platform for mission designers to optimize launch stack configurations for constellations as well as multi-manifest missions.



Figure 2. Left, ESPA and auxiliary payloads launching with primary spacecraft
Right, ESPA stack for ORBCOMM OG2 spacecraft

a. Capability

ESPA capability was established with a Qualification Test in 2002, defining the "ESPA class" auxiliary payload (APL) as a 400-lb satellite with center of gravity (CG) at 20 inches or less (181 kg at 50.8 cm) and a Ø15-inch bolt circle interface. The test program used load factors taken from a mass acceleration curve (MAC) for launch vehicle secondary structure: 10g in two directions applied simultaneously for a 14.1g vector sum (subsequently reduced to 8.5g/8.5g for a 12.0g vector sum). This combination of capability and load factors became a reference standard for small satellites, and will be referred to in this document as "heritage" ESPA class.

Interest in carrying larger APLs led to the development of the ESPA Grande Ø24-inch-diameter interface, qualified by analysis for a 700-lb satellite at 20 inches (318 kg at 50.8 cm). An alternate ESPA interface consisting of four discrete mounting pads was later developed for the AFRL EAGLE Program to carry the heritage APL class of 400 lb at 20 inches. The EAGLE 4-point mount was qualified by test in 2014.

Two test programs during the period of 2016-2018 resulted in significant changes to ESPA with respect to port payload capability and standard interfaces. In 2016, a Delta Qualification Test was performed on the standard ESPA with Ø15" ports, and in 2018 the ESPA Grande Ø24" port capability was established with a Qualification Test.

- The motivation for re-testing the standard ESPA structure was the desire to carry APLs on the Ø15" port that exceeded the heritage definition of ESPA class. A substantial increase was achieved because high strength margins in the structure had been carried since the early days of ESPA, due to a reduction in published flight loads following the original test, and the re-design of the ESPA port after STP-1 (the maiden ESPA flight) to facilitate integration of large APLs. This Delta Qualification test program also introduced the "ESPA Heavy" interface, with 5/16" fasteners, to further increase APL capacity.
- Qualification testing of the ESPA Grande similarly quantified increased capacity for the Ø24" port. As for the standard ESPA, a modified interface called Grande Heavy was introduced using 5/16" instead of 1/4" fasteners, but because of the increased number of fasteners on the Ø24" port compared to the Ø15" port, the Grande Heavy interface provides no additional payload capability, but does offer higher margins for risk-averse mission designers. With the new tested capability, ESPA Grande APLs inside a 4-meter fairing are effectively volume constrained rather than mass constrained.

The new, tested capabilities for the Ø15" and Ø24" ports are documented in Section 3 of this document. Furthermore, as a result of the new, substantially higher, ESPA

payload capabilities, the ESPA mass acceleration curve (MAC) has been introduced to more accurately specify design load factors for ESPA payloads; the ESPA MAC and the rationale for its use are detailed in Section 4. The ESPA MAC is used as the basis for all port capabilities defined in this document, but, for reference, port capabilities are also provided that are based on the heritage load factors (8.5g/8.5g) regardless of APL mass.

b. Nomenclature

Common ESPA ring configurations are identified with a part number defined by

ESPA n-d-h

n = number of circular ports,

d = port diameter in inches, and

h = ring height in inches.

The standard ESPA shown in Figure 1 is an ESPA 6-15-24. The most common configuration for ESPA Grande is an ESPA 4-24-42. When at least one 4-point mount is used instead of a circular port, the designation "4PT" is added. For example, the EAGLE ESPA had two ports and four instances of 4-point mounts; its part number was ESPA 2-15-24-4PT.

ESPA is flexible in terms of structure modifications that can be implemented to facilitate mission objectives (see Section 5). Deviations from the standard configurations, such as custom wall thickness or internal flanges, are captured in the part number with a "SPECIAL" designation.

c. Interfaces

Port options are configurable depending on APL interfaces; the most common are the Ø15" and Ø24" ports and the ESPA 4-point mount (see Figure 6). Recently, there has been interest in an Ø11.7" port for smaller vehicles. ESPA interfaces can utilize 1/4", 5/16", M7, or M8 fasteners. An ESPA can consist of just one interface type, or multiple types to accommodate varying payload sizes. These interfaces are described in detail in Section 3.

d. Height

The height of the ESPA can be user specified, but typically the standard ESPA with Ø15" ports is 24" tall, and the ESPA Grande with Ø24" ports is 42" tall. For a given port size, there is a minimum height an ESPA must have to provide clearance between the port and primary flanges on the top and bottom interfaces. Generally, the minimum height of an ESPA ring is at least 8" greater than the port diameter.

The height of the ESPA defines the vertical volume an APL can span. The ring height usually provides adequate height to span the ESPA payloads. However, if more APL vertical height is needed, the ESPA height can be increased up to 60" (the current forging size limit). An option to increasing the ESPA height is to add spacer rings above and/or below the ESPA.

e. Mass

The mass of an ESPA is proportional to its height. The number or type of port interfaces has minimal effect because when mass is removed in the port cutout, it is balanced out by the added mass in the boss port. Figure 3 illustrates how the mass of the ESPA nominally changes with height.

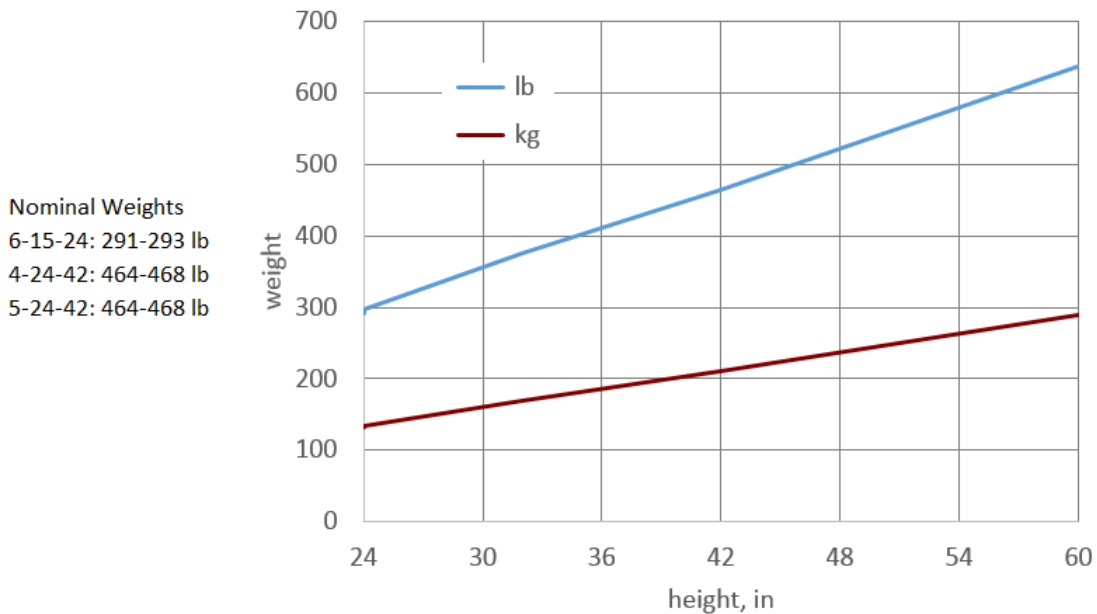

Figure 3. ESPA weight vs height

f. Baseline Configurations

While the ESPA ring is regularly customized to fit the unique needs of the customer, Table 1 outlines three basic configurations: the standard ESPA, ESPA Heavy (with 5/16" instead of 1/4" fasteners), and ESPA Grande. These configurations define baseline ESPA structures that can be customized for mission-specific requirements.

Table 1. Baseline ESPA configurations

| Name | Part # (n-d-h) | Port Diameter | # of Ports | ESPA Height | Interface Fastener Size | Port Payload Capacity | ESPA Mass |
|------------------|-------------------|------------------|---------------|----------------|----------------------------|-----------------------------|--------------------|
| Standard ESPA | 6-15-24 | 15" | 6 | 24" | 1/4" Fasteners | 567 lb * (257 kg) | 293 lb (133 kg) |
| ESPA Heavy | | | | | 5/16" Fasteners | 991 lb * (450 kg) | |
| ESPA Grande | 4-24-42 | 24" | 4 | 42" | 1/4" Fasteners | 1543 lb * (700 kg) | 465 lb (211 kg) |
| Grande Heavy | | | | | 5/16" Fasteners | 1543 lb * (700 kg) | |

M7 or M8 fasteners can replace 1/4" or 5/16" fasteners.

* Port payload capacities assume payload center of gravity at 20 inches (50.8 cm).

* Capacities decrease to 485 lb, 710 lb, and 1026 lb (220 kg, 322 kg, and 465 kg) if utilizing the heritage ESPA load factors (8.5g/8.5g) regardless of APL mass.

3. Interfaces

a. Type

The most common ESPA interface types, their respective dimensions, and fastener details are outlined below.

- Ø15" circular port with 24 fasteners (Figure 4): standard ESPA and ESPA Heavy interfaces.
- Ø24" circular port with 36 fasteners (Figure 5): standard ESPA Grande interface, provides larger secondary payload capacity.
- 4-point mount with 8 fasteners and locating pin at each mount pad (Figure 6): a discrete interface developed for the AFRL EAGLE Program.
- Ø11.732" circular port with 18 fasteners: smaller port for smaller payloads.

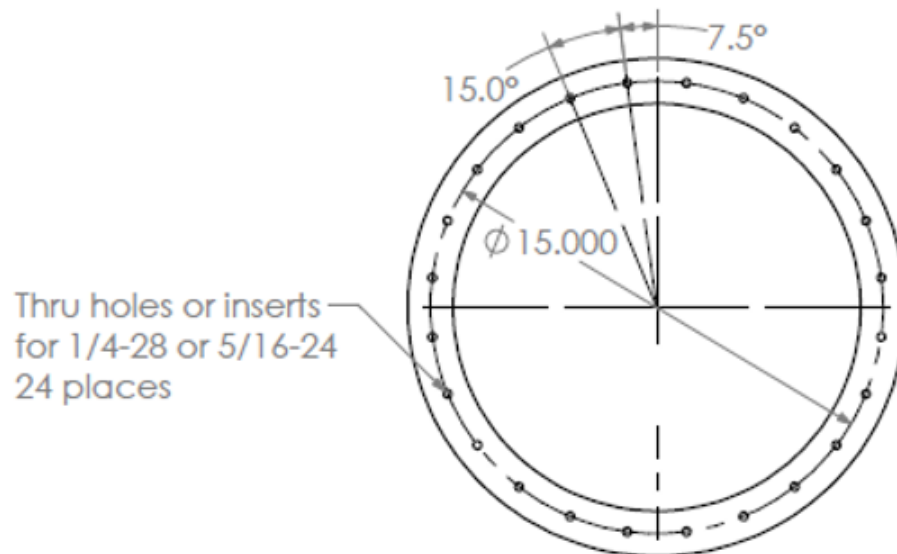

Figure 4. Ø15-inch-diameter port dimensions

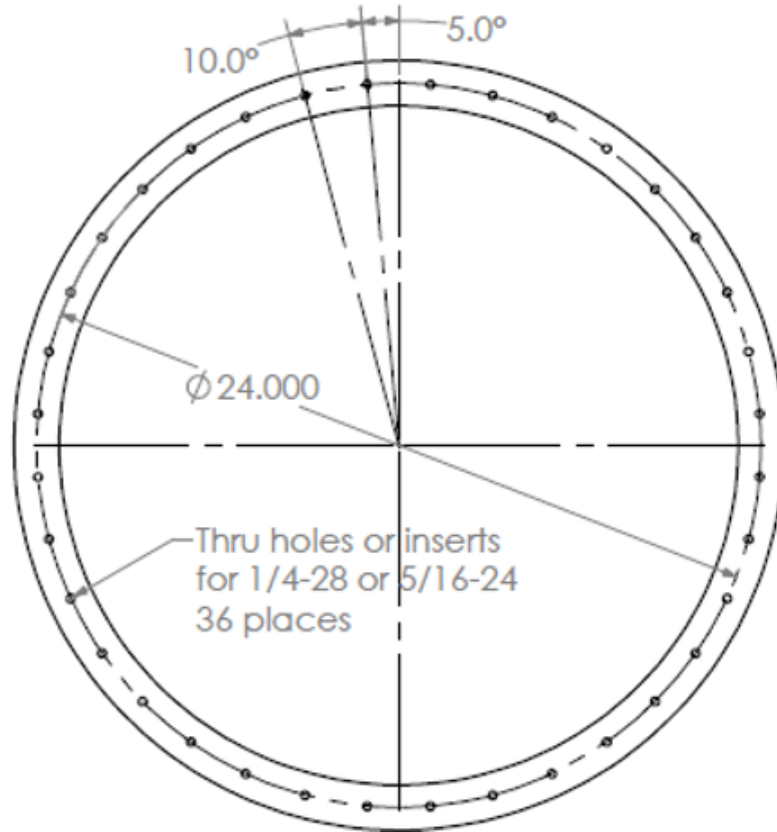

Figure 5. Ø24-inch-diameter port dimensions

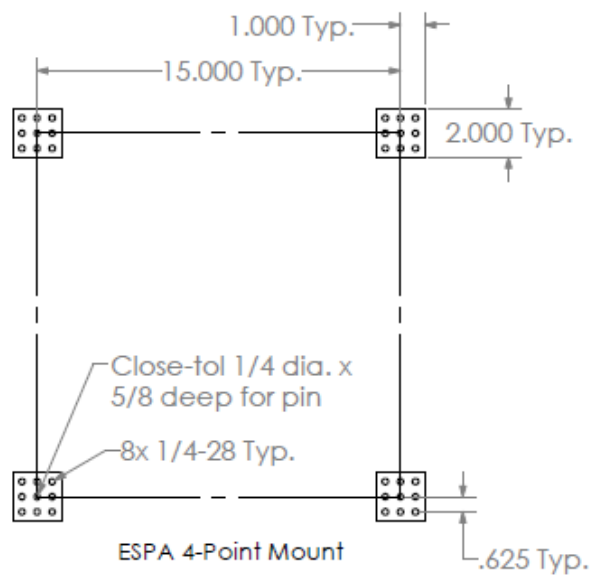

Figure 6. 4-point mount interface dimensions

b. Quantity

The number of interfaces that can fit on an ESPA is defined by the respective interface size. Interfaces are usually spaced evenly around the ESPA to maximize capacity while maintaining structural integrity.

- Ø15" circular port allows a maximum of 6 ports.
- Ø24" circular port allows a maximum of 5 ports, although 4 ports is more commonly used.
- 4-point mount allows a maximum of 6 interfaces.
- Ø11.7" circular port allows a maximum of 12 ports.

While these are the maximum number of interfaces when all are of the same type, there is the option, as mentioned earlier, to vary the interfaces and mix and match. For example, an ESPA could have three Ø15" ports and two Ø24" ports, or two Ø15" ports and six Ø11.7" ports. The exact maximum number of interfaces when mixing and matching is mission specific.

c. Fasteners

ESPA can be configured for various fastener options for mounting to any interface. The standard fastener size is 1/4". There is also a 5/16" fastener option, referred to as ESPA Heavy, that allows a larger payload capacity for the Ø15" interface. This fastener size can also be used for the Ø24" port; it does not provide additional capability for this interface but does offer higher margins for risk-averse mission designers. For those looking to maintain their design in metric units, we also offer the option to mount via M7 or M8 fasteners. It is important to note that Moog does not provide these fasteners and that the customer must acquire them separately from the ESPA.

When selecting fasteners for ESPA Ø15" and Ø24" ports, the fastener length should allow for 0.7" of material in the ESPA portion of the mated structures.

While payloads are typically mounted by inserting the fastener from the inside of the ESPA cylinder, if the desired ESPA configuration does not permit this, Moog offers threaded insert options for fastening from the outside.

d. Load Capacity

The load capacity of the ESPA interfaces is defined by the interface diameter and the fastener used for mounting (see Table 2). The following payload capacities are for a payload center of gravity (CG) that is 20" (50.8 cm) from the interface plane.

- Ø15" circular port with 1/4" fasteners has a 567 lb (257 kg) payload capacity, (485 lb/220 kg with heritage ESPA load factors of 8.5g/8.5g).
- Ø15" circular port with 5/16" fasteners has a 991 lb (450 kg) payload capacity (710 lb/322 kg with heritage ESPA load factors).
- Ø24" circular port with 1/4" fasteners has a 1543 lb (700 kg) payload capacity (1026 lb/465 kg with heritage ESPA load factors).
- Ø24" circular port with 5/16" fasteners does not increase capability compared to 1/4" fasteners but does offer higher margins for risk-averse mission designers.
- 4-point mount with 1/4" fasteners has a 400 lb (181 kg) payload capacity.

The payload carrying capability of an ESPA port is dependent on the mass of the secondary payload and the offset of the payload's CG from the ESPA port interface plane. Note, the mass and height of the secondary spacecraft separation system must be included in the mass and CG estimates. Figure 7 compares APL mass allowables versus the CG offset from the ESPA port.

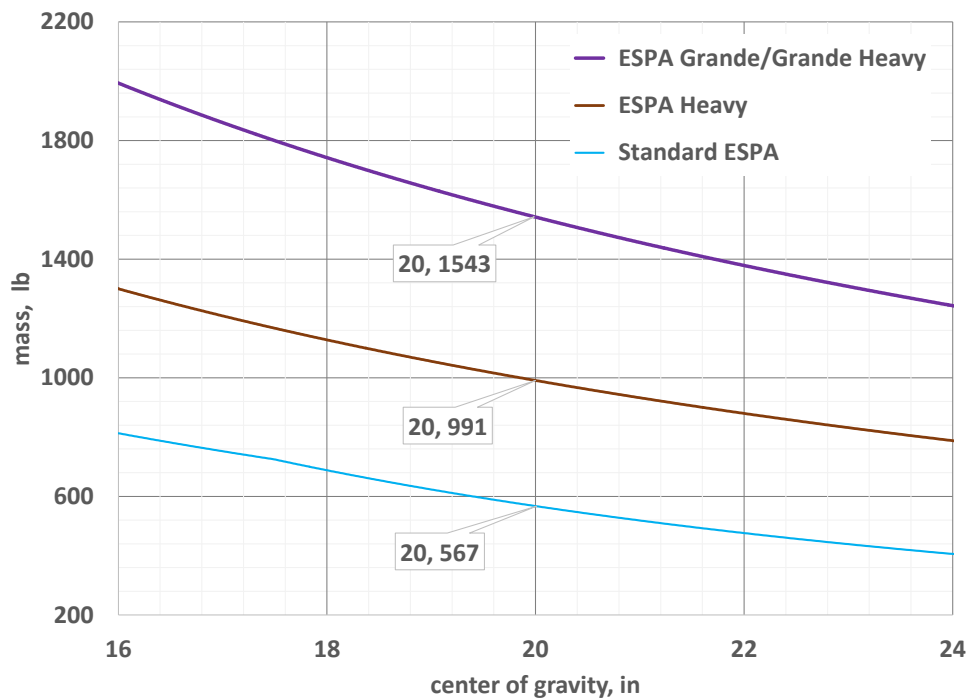

Figure 7. ESPA payload mass allowable vs distance from interface plane to payload center of gravity

e. *Volume*

The allowable payload volume is limited by the dimensions of the adjacent elements in the integrated payload stack (IPS), typically the neighboring payloads on either side and the primary payload above. Given knowledge of the IPS, the available volume would extend to these neighboring payloads while leaving enough separation to provide sufficient dynamic "rattle space." However, without knowledge of the IPS volumes, recommended volume guidelines, shown in Figure 8, have been published in the EELV Rideshare User's Guide.¹

- With a standard ESPA Ø15" port, the allocated payload volume is a 24" x 28" x 38" box as pictured in Figure 8.
- For the ESPA Grande with five Ø24" ports, the allocated volume is a 42" x 46" x 56" box also pictured in Figure 8. Note that these dimensions are for a 5-meter fairing. For a 4-meter fairing, the volume is 42" x 46" x 38".

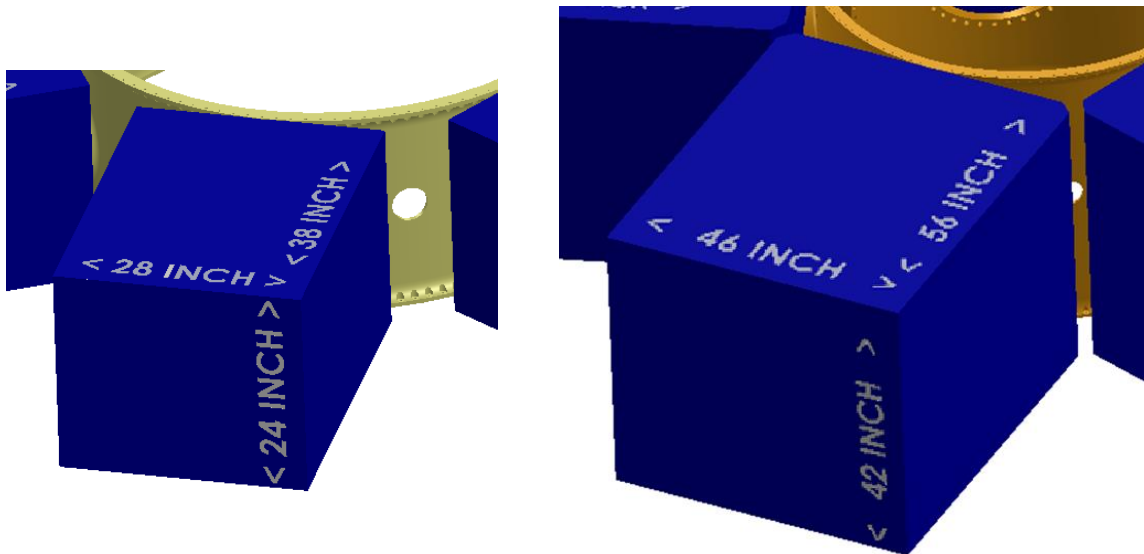

Figure 8. Left, Standard ESPA payload volume;
Right, ESPA Grande payload volume for 5-meter fairing

It is important to note that these dimensions are for typically sized ESPAs, assuming Ø15" and Ø24" interfaces. The vertical APL dimension, as mentioned in Section 1, is not necessarily limited to 24" and 42", the height of the baseline ESPAs. If a larger volume is required in the vertical dimension, a taller ESPA can be manufactured to provide such additional capability. An alternate approach is to use spacer rings to

¹ Evolved Expendable Launch Vehicle Rideshare User's Guide (EELV RUG), Space and Missile Systems Center Launch Systems Enterprise Directorate (SMC/LE), May 2016.

increase the IPS height; as an example, ULA uses "C adapters" between the ESPA and the Centaur forward adapter. Therefore, additional space may be available for secondary payloads. This requires coordination with the launch vehicle provider and/or the mission integrator.

APLs can take advantage of the ESPA internal volume, if this volume is not occupied by a propulsion system or other mission element. In the extreme, for an ESPA with no internal elements, an APL would be allocated a "pie slice" of the internal volume, with allowance for dynamic "rattle space" between adjacent slices. Tip-off of the separation system must be accounted for to ensure any APL structure that extends into the internal volume will exit the volume upon APL deployment without contacting the port inner diameter. Allocation of ESPA internal volume for APLs should be confirmed, once the mission IPS is defined, by the launch vehicle provider and/or the mission integrator.

Another use of the internal volume is to include tertiary payloads that deploy after APL separation. As an example, the ESPA 6U Mount (ESPA SUM), developed and qualified by Moog for NASA, mounts one or two CubeSat dispensers on the interior of a Ø15" ESPA port. This approach allows for installation of an externally mounted APL on the same port as an internal 6U (or two 3Us) CubeSat payload. The ESPA SUM can be enhanced for alternative payload configurations for both Ø15" and Ø24" ports, and CubeSat dispenser manufacturers are developing similar systems.

f. Separation Systems

For the auxiliary payloads, it is important to note that the separation system as well as the spacecraft have to fit in the allocated payload volume (Section 3.e.), and that the separation system is included in the CG distance. Separation of the ESPA from the launch vehicle at the primary interface is sometimes required, e.g., for propulsive ESPA rings.

Moog does not provide separation systems with ESPA. ESPA separation systems for auxiliary payload separation are manufactured by [Planetary Systems Corporation](#) (PSC) of Silver Spring, Maryland; [Sierra Nevada Corporation](#) (SNC) of Louisville, Colorado; and [RUAG Space](#), a Swiss company with manufacturing facilities in Huntsville, Alabama. All three of these manufacturers also offer Ø24" separation systems, as well as other custom diameters, but only SNC has an option for 5/16" fasteners. Currently, RUAG is the only provider of separation systems for the Ø62" (1575 mm) ESPA primary interface. No separation systems were tested with ESPA, and users should verify current qualification levels with their separation system vendor.

g. Summary

Table 2 outlines the common ESPA variants.

Table 2. Summary of common ESPA configurations

| Interface | Max Port Count | ESPA Height | Port Interface Fastener Size | Port Payload Capacity | ESPA Mass | Guideline Payload Volume |
|---------------|----------------|-------------|-----------------------------------|-----------------------|--------------------|--------------------------|
| Ø 15" | 6 | 24" | 1/4" Fasteners | 567 lb * (257 kg) | 293 lb (133 kg) | 24"x28"x38" |
| | | | 5/16" Fasteners | 991 lb * (450 kg) | 293 lb (133 kg) | |
| Ø 24" | 5 | 42" | 1/4" Fasteners 5/16" Fasteners | 1543 lb * (700 kg) | 465 lb (211 kg) | 42"x46"x56" ** |
| 4-Point Mount | 6 | 24" | 1/4" Fasteners | 400 lb (181 kg) | 295 lb (134 kg) | 24"x28"x38" |
| Ø 11.7" | 12 | 24" | 1/4" Fasteners | 300 lb (136 kg) | 263 lb (119 kg) | TBD |

M7 or M8 fasteners can replace 1/4" or 5/16" fasteners.

Port payload capacities assume payload center of gravity at 20 inches (50.8 cm).

* Capacities decrease to 485 lb, 710 lb, and 1026 lb (220 kg, 322 kg, and 465 kg) if utilizing the heritage ESPA load factors (8.5g/8.5g) regardless of APL mass.

** Volume shown is for 5-meter fairing; replace 56" with 38" for 4-meter fairing

Figure 9 displays some examples of ESPA configurations ranging from mission concepts to specific versions implemented for previous missions. The LCROSS ESPA was a standard ESPA 6-15-24. Two Small-Launch ESPA (SL ESPA) configurations have been designed for small launchers with Ø38.81" primary interface (can be scaled down to Ø24"); SL ESPA 15 is 15" tall with Ø8" ports and SL ESPA 24 is 24" tall and has Ø15" ports. The DSX ESPA is a standard ESPA with only four Ø15" ports. The OMEGA (Orbiting Medium Explorer for Gravitational Astronomy) ESPA was a propulsive ring concept with a lightweighted 4-port ESPA Grande. The EAGLE (ESPA Augmented Geostationary Laboratory Experiment) ESPA had two Ø15" ports and four instances of the ESPA 4-point mount. SHERPA is a 5-port ESPA Grande as specified by Spaceflight Inc. for rideshare missions. The first of two ORBCOMM ESPA missions was the first flight of stacked ESPAs. The ESPA 12-11.7-24, featuring twelve Ø11.7" ports, is a new configuration specifically for the emerging satellite class between traditional ESPA (i.e., 400 lb) and CubeSat; the "OS" variant has offset ports.

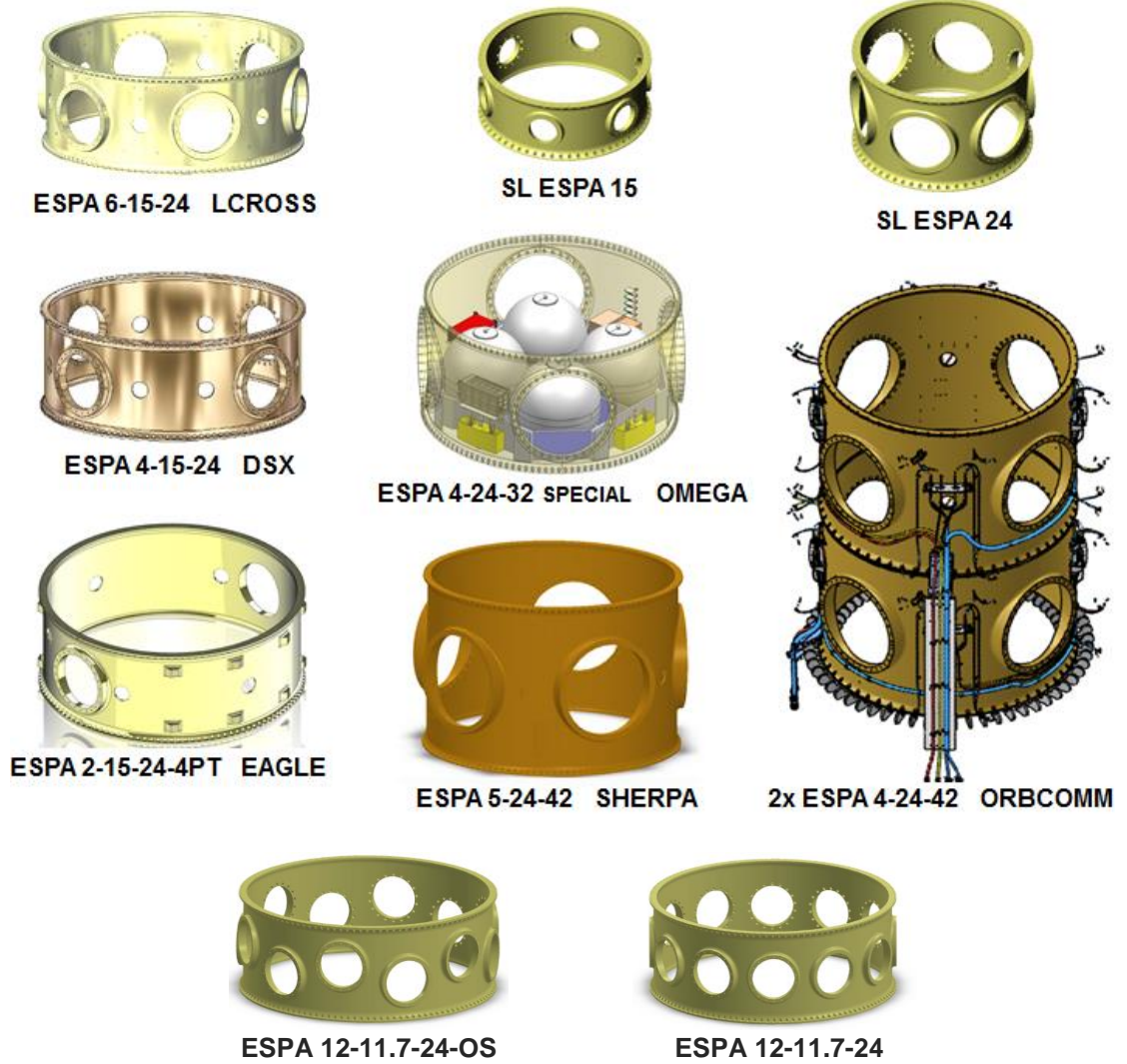

Figure 9. Partial ESPA family portrait

4. Flight Environments

a. Quasi-Static Loads

Since the ESPA development in the early 2000s, ESPA satellite design load factors were defined as a one-size-fits-all 8.5g load factor applied simultaneously in both lateral and axial directions (vector sum of 12g) of the launch vehicle. This g level was taken from a mass acceleration curve used to design launch vehicle secondary structure. It was selected based on the ESPA port capacity qualified by test in 2002, i.e., 400 lb at 20 inches (181kg at 51cm). In the period between 2016 and 2018, testing performed on both the ESPA Ø15" port and the ESPA Grande Ø24" port qualified much higher port capacities. This new capability resulted in the need to define a realistic design load factor schedule, based on payload mass and not "one-size-fits-all." Moog recommends the use of the ESPA Mass Acceleration Curve (ESPA MAC) which is based on the MAC developed by NASA's Jet Propulsion Laboratory (JPL) in the 1980s and is commonly used throughout the aerospace community. One caveat applied for the ESPA MAC, not used in the JPL MAC, is that the axial load factor cannot be lower than the corresponding load factor specified in the EELV User's Guides.^{2 3} At this time, 6.5g represents this minimum axial load factor value for the ESPA MAC. The ESPA Mass Acceleration Curve is shown in Figure 10 and Table 3.

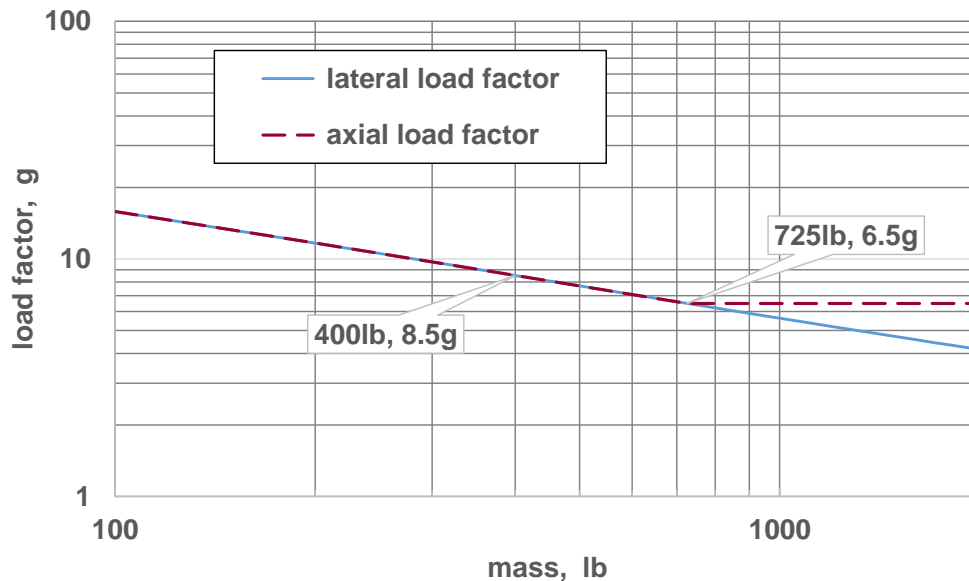

Figure 10. Mass acceleration curve (MAC) for ESPA payloads

² Atlas V Launch Services User's Guide, United Launch Alliance, March 2010.

³ Falcon 9 Launch Vehicle Payload User's Guide, Space Exploration Technologies Corp., October 2015.

Table 3. Quasi-static load factors from ESPA Mass Acceleration Curve

| APL mass | | acceleration, g | | |
|----------|------|-----------------|---------|------------|
| kg | lb | axial | lateral | vector sum |
| 91 | 200 | 11.7 | 11.7 | 16.5 |
| 136 | 300 | 9.7 | 9.7 | 13.7 |
| 181 | 400 | 8.5 | 8.5 | 12.0 |
| 227 | 500 | 7.7 | 7.7 | 10.9 |
| 272 | 600 | 7.1 | 7.1 | 10.0 |
| 329 | 725 | 6.5 | 6.5 | 9.2 |
| 363 | 800 | 6.5 | 6.2 | 9.0 |
| 454 | 1000 | 6.5 | 5.6 | 8.6 |
| 544 | 1200 | 6.5 | 5.2 | 8.3 |
| 635 | 1400 | 6.5 | 4.8 | 8.1 |
| 726 | 1600 | 6.5 | 4.6 | 7.9 |
| 816 | 1800 | 6.5 | 4.3 | 7.8 |
| 907 | 2000 | 6.5 | 4.2 | 7.7 |

*

heritage ESPA class *

b. Sinusoidal Vibration

Launch vehicle providers define sine vibration environments at the spacecraft interface plane in their user's guides. ESPA port sine vibration environments are not defined in this user's guide as the structure that is included in the payload stack will have an effect on the sine vibration environment. The best source for sine environments is the launch vehicle provider.

c. Random Vibration

ESPA port random vibration environments are driven by acoustic excitation of the ESPA cylinder and by transmission of mechanical vibration environments from the launch vehicle. Random vibration testing for small spacecraft is considered acceptable as stated in SMC-S-016.⁴

SMC-S-016 includes the following statement:

8.3.6 Vehicle Vibration Test: The vibration test may be conducted instead of an acoustic test for small, compact vehicles that are not sensitive to acoustic excitation. Such vehicles may be excited more effectively via interface vibration. These vehicles should have a weight less than 400 lb.

⁴ Test Requirements for Launch, Upper-Stage and Space Vehicles, Space and Missile Systems Center, September 2014.

If a spacecraft exceeds 400 lb, then acoustic testing is recommended. Acoustic testing has the advantage of requiring only one test setup. This is compared to random vibration testing where three setups are required to test the three principal axes of the spacecraft. Less spacecraft handling reduces risk.

The Moog experience based ESPA port maximum predicted random vibration environment (P95/50) for spacecraft weighing less than 400 lb is provided in Figure 11. This environment is a three-axis max. The appropriate protoqualification or qualification margins should be applied for spacecraft testing. SMC-S-016 identifies these margins. SMC-S-016 also identifies test durations per axis.

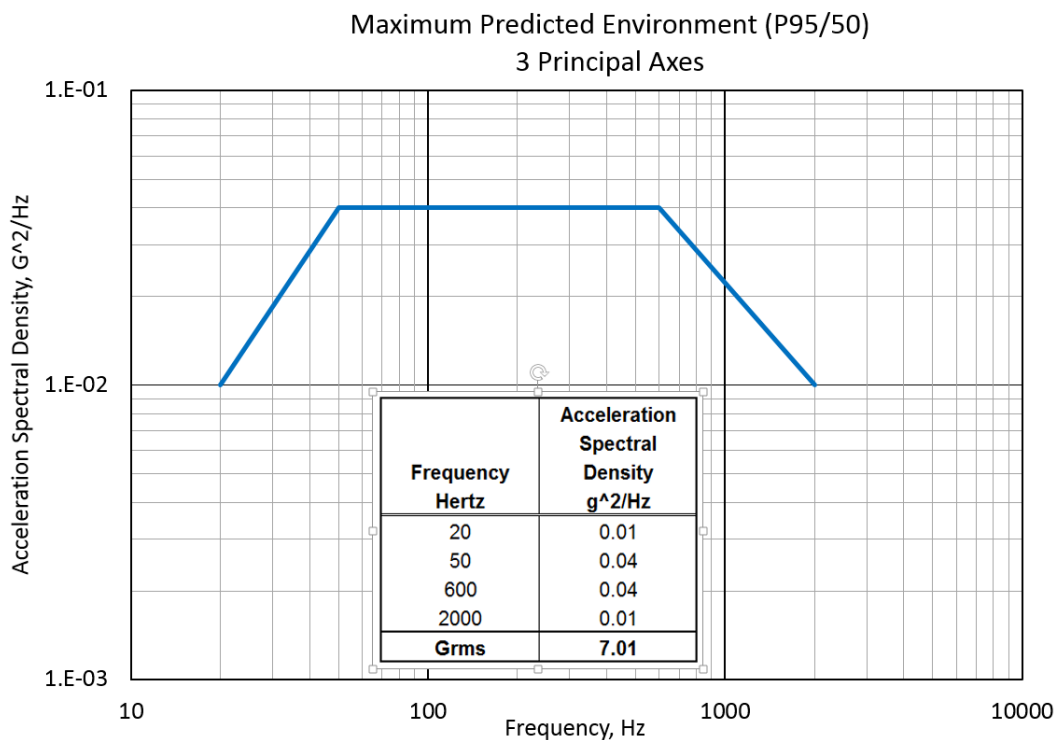

Figure 11. ESPA port random vibration environment

d. Acoustics

Acoustic environments are launch vehicle and launch pad specific and are defined in the launch vehicle payload planner's guides. The volumetric fill within the payload envelope has an influence on the acoustic environment. The higher the fill factor, the higher the acoustics. Note that the largest influence on the fill factor is the primary payload. The generic fill factor acoustic environments in the launch vehicle user's guides are a good starting point for ESPA payload acoustic analysis. Mission unique

acoustic environments can be predicted by the launch vehicle providers if the mission fill factors fall outside the generic fill levels.

e. Shock

ESPA payloads need to survive launch vehicle induced shocks, primary spacecraft separation shock, adjacent spacecraft separation shock and any self-induced shock events. An envelope of these shock events is provided in Figure 12. This shock environment should be updated once the launch vehicle and payload stack have been fully defined.

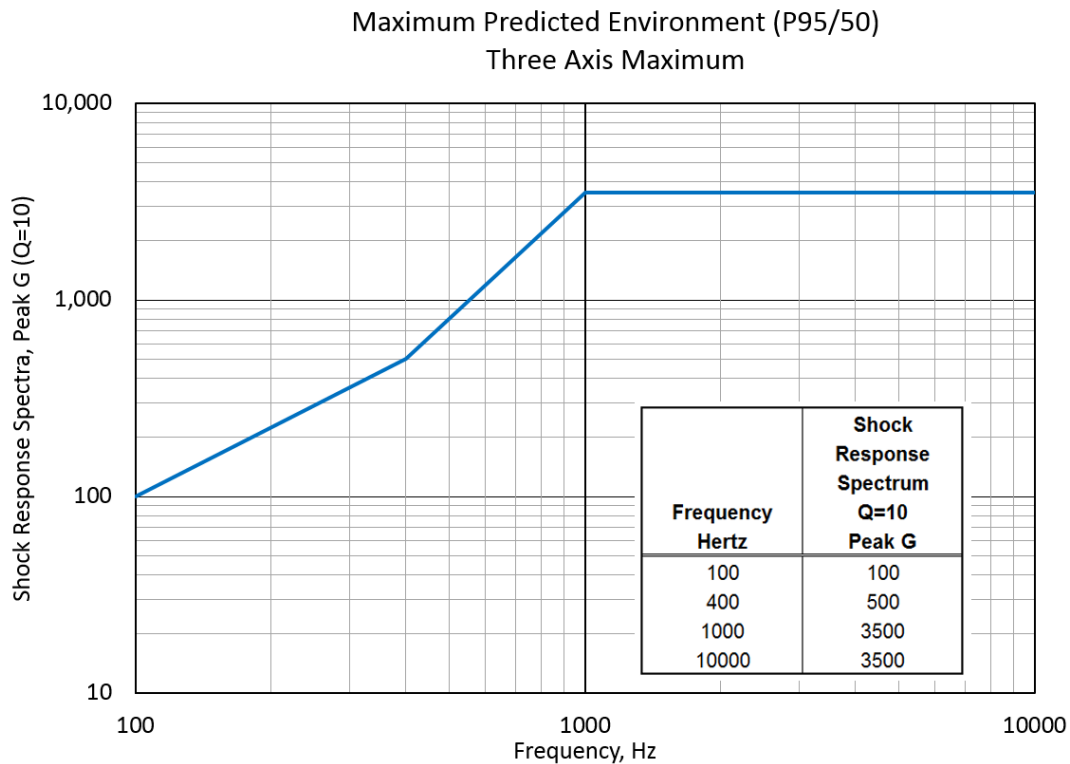

Figure 12. ESPA port shock environment

5. Customization

Outside of the various size and interface options, there are additional features that can be added and customized to fit specific customer needs. These include:

- Harness attachment and miscellaneous mounting holes
- Integral clampband flanges
- Optional primary interface diameters, Ø24" to Ø120"
- Alternate ESPA payload mounting configurations
- Wall mounting features
- Internal flanges
- Thinned walls/machined pockets for mass optimization
- SoftRide vibration isolation provided by Moog. For more information see the SoftRide User's Guide at moog.com

Moog will work with customers to maximize the use and capability of each ESPA. Please use the contact information listed at the end of this guide to further discuss how we can customize an ESPA for your unique mission.

6. Moog Mission Support

Moog also provides ESPA mechanical ground support equipment (MGSE) for lease or purchase. The ESPA stand and ESPA lifting ring support ESPA processing and payload integration. An ESPA stack is assembled on top of the ESPA stand via the ESPA Lifting Ring as illustrated in Figure 13. The lifting ring helps to maintain the flatness and circularity of the ESPA primary interfaces to facilitate integration with adjacent structures or separation systems. For the integration of each payload, a break-over fixture can be used to maneuver each payload in place. This equipment enables auxiliary payloads to be stored in any orientation and then lifted and rotated into the necessary orientation for mounting. A spacecraft-to-ESPA-port adapter plate is required to interface with the break-over fixture.

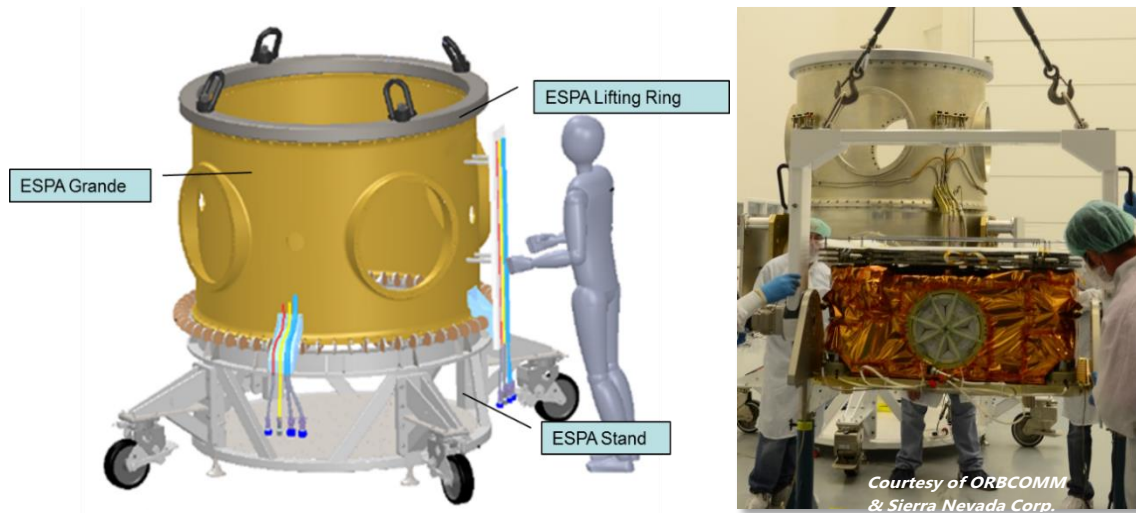

Figure 13. Left, ESPA Grande on top of custom ESPA stand with ESPA lift ring on top.
Right, break-over fixture for horizontal integration of auxiliary payloads

Additionally Moog has experts who can provide mission integration services and spacecraft fueling services. See moog.com for more information.

7. Frequently Asked Questions

- How does the naming convention apply to Small Launch ESPA, 4-point mounts, large diameter rings, ESPA Heavy, ESPA Grande, etc.?

ESPA has many variants with different capabilities, accordingly terms like Standard and Grande can have different meanings. Moog's ESPA naming configurations (ESPA n-d-h, where n=number of circular ports, d=port diameter in inches, and h=ring height in inches) assumes the primary interface to be 62" (1575 mm), and so larger and smaller diameter rings are not defined in this format. ESPA 6-15-24 is often considered the "Standard ESPA." ESPA 4-24-42 is commonly referred to as "ESPA Grande." When at least one 4-point mount is used instead of a circular port, the designation "4PT" is added. Deviations from the standard configurations, such as custom wall thickness or internal flanges, are captured in the part number with a "SPECIAL" designation.

- How much mass can be accommodated by an ESPA port?

APL mass is related to port diameter and CG offset from the ESPA port interface. A larger interface diameter is required for higher APL masses. Section 3 of this document provides tested port capabilities.

- Is ESPA wall thickness a design variable?

ESPA wall thickness can be reduced depending on secondary payload mass (this option isn't typically used).

- What is the minimum ESPA height?

Port diameter is related to minimum ESPA height. The Ø15" port requires a 23" tall ESPA. The Ø24" port requires a 32" tall ESPA. Generally, the minimum height of an ESPA ring is 8" greater than the port bolt circle diameter.

- What is the maximum ESPA height?

Ring forging availability determines the maximum height of ESPA (currently 60").

- What is the maximum ESPA diameter?

ESPA maximum diameter is limited to ring forging and machine shop capability (currently 120").

- Why should I care about the location of the ESPA APL center of gravity?

Both Ø15" and Ø24" ports are designed for the APL CG to be less than or equal to 20" from the port interface. ESPA port capability is defined by a mass-times-CG moment, not just a mass.

- Do changes to the baseline ESPA configurations require requalification?

Typically, ESPA modifications can be analyzed to show that requalification is not required. Most changes can be designed, if necessary, using "No Test" factors of safety, traceable to the qualification test.

8. Contact Information

The ESPA product family falls under the jurisdiction of the Export Administration Regulations (EAR). Please contact Moog for additional information.

Scott Pendleton
ESPA Production Lead
650-960-4231
spendleton@moog.com

Joe Maly
ESPA Product Manager
650-960-4226
jmaly@moog.com

Appendix ESPA Flight Heritage and Document Revision History

| Mission | Launch Vehicle | Carrier | ESPA Type | Launch Date |
|----------------------------|----------------|-----------------|-------------|-------------------------------|
| STP-1 | Atlas V | ESPA | 6-15-24 | March 2007 |
| LCROSS | Atlas V | Propulsive ESPA | 6-15-24 | June 2009 |
| OG2 Mission 1 | Falcon 9 | ESPA Grande (2) | 4-24-42 | July 2014 |
| AFSPC-4 | Delta IV | ESPA | 6-15-24 | July 2014 |
| OG2 Mission 2 | Falcon 9 | ESPA Grande (3) | 4-24-42 | December 2015 |
| AFSPC-6 | Delta IV | ESPA | 6-15-24 | August 2016 |
| SHERPA - Spaceflight | Falcon 9 | ESPA Grande | 5-24-42 | Planned for 2017 but canceled |
| EAGLE - AFRL | Atlas V | Propulsive ESPA | 2-15-24-4PT | April 2018 |
| SSO-A - Spaceflight | Falcon 9 | ESPA | 6-15-24 | December 2018 |
| STP-2 (DSX Mission) - AFRL | Falcon Heavy | ESPA | 4-15-24 | Planned for 2019 |
| LDPE (STP-3) - SMC/AD | Atlas V | Propulsive ESPA | 0-15-24-4PT | Planned for 2019 |

REVISIONS

| Rev | Description | Date | Author | Approved |
|-----|-----------------|----------|---------|----------|
| 0 | Initial Release | Nov 2018 | D Mages | J Maly |