

SIMERA

SENSE

xScape200 VNIR Optical Front-End

Datasheet

Document Number: 036603
Author(s): D van Staden
Revision: 3

Document History

Revision	Date	Details
1	2019-09-13	First draft of document
2	2019-12-06	All technical information updated
3	2019-12-13	Added Section 3 and Section 4

Table of Contents

1. Overview	7
1.1 Features	8
1.2 Applications.....	8
1.3 Key Specifications.....	9
2. Performance of the xScape200 VNIR Optical Front-End	10
2.1 Polychromatic (450 nm – 950 nm) Modulation Transfer Function	10
2.2 Spectral MTF	12
2.3 System Transmission.....	13
2.4 Geometric Distortion	14
2.5 Polychromatic (450 nm – 950 nm) Wavefront Error	15
2.6 Relative Illumination	15
3. Environmental Ratings	16
4. Physical Characteristics	17

List of Figures

Figure 1-1: xScape200 VNIR Optical Front-End	7
Figure 2-1: Polychromatic MTF as Function of Spatial Frequency at Different Field Angles	10
Figure 2-2: Polychromatic MTF Across Image Plane at Different Spatial Frequencies	11
Figure 2-3: On-axis Monochromatic MTF as Function of Spatial Frequency	12
Figure 2-4: Transmission (Obscuration Considered) Across Spectral Range at Different Angles	13
Figure 2-5: Distortion Across Image Plane at Different Wavelengths.....	14
Figure 2-6: Polychromatic RMS Wavefront Error Across Image Plane.....	15
Figure 2-7: Relative Illumination Across Image Plane	15
Figure 4-1: OFE Mechanical Layout and Dimensions	17

List of Tables

Table 1-1: Key Specifications	9
Table 3-1: Environmental Absolute Maximum Ratings	16
Table 4-1: Physical Characteristics	17

List of Abbreviations

Abbreviation	Description
MTF	Modulation Transfer Function
OFE	Optical Front-End
RMS	Root Mean Square
TDI	Time Delay Integration
VNIR	Visible and Near-Infrared

1. Overview

The xScape200 VNIR Optical Front-End (OFE) maintains optical performance across the spectral range from 450 nm to 950 nm. This product is ideal for multispectral and hyperspectral imaging applications across the visible and near infra-red (VNIR) spectra.

The OFE is designed to survive the harsh structural loading, which is experienced during launch into space, as well as the severe operating conditions experienced in the space environment. Special attention was given to maximize the front aperture and focal length of the OFE to optimise the performance for a 12U CubeSat structure. A rendering of the OFE is shown in Figure 1-1.



Figure 1-1: xScape200 VNIR Optical Front-End

1.1 Features

Key features of the xScape200 VNIR Optical Front-End are the following:

- Maintains high MTF across the spectral range over the entire image plane
- Long focal length and large aperture design packaged to fit into standard 12U CubeSat structure
- Robust and athermalised structural design is optimised to survive launch loads and maintain optical performance between -10°C and 50°C under high vacuum
- Lightweight design results in reduced launch cost
- Reduced distortion allows for time delay integration (TDI) imaging
- The expected lifetime of more than three years
- Environmental verification based on GSFC-STD-7000

1.2 Applications

- Precision agriculture
- Forestry and land use
- Energy and infrastructure
- Coastal monitoring
- Air quality
- Resource and infrastructure monitoring

1.3 Key Specifications

The optical and mechanical specifications of the xScape200 VNIR Optical Front-End are given in Table 1-1. These are the ideal theoretical performance values and actual performance is expected to deviate from these values.

Table 1-1: Key Specifications

Description	Value
F-number	5.6
Focal length	1067 mm ± 1 mm
Front Aperture Diameter	190 mm
Obscuration Diameter	84.4 mm
Full Field of View	2.01°
Spectral Range	450 – 950 nm
Transmission of Unobscured System	> 83%
Distortion	< 0.04%
On-Axis MTF ¹	28% @ 100 lp/mm 21% @ 157 lp/mm
Max Field MTF ¹	25% @ 100 lp/mm 19% @ 157 lp/mm
Image Circle Diameter	38 mm
Operating Temperature	-10 °C to 50 °C
Mass	11.2 kg
Flange Focal Distance	3.96 mm (See Figure 4-1)
Dimensions	200 x 200 x 284 mm

¹Simulated results obtained from optical model

2. Performance of the xScape200 VNIR Optical Front-End

This section provides the as designed optical performance of the OFE.

2.1 Polychromatic (450 nm – 950 nm) Modulation Transfer Function

The modulation transfer function (MTF) of the xScape200 VNIR Optical Front-End across the polychromatic spectral range is presented in Figure 2-1. The figure provides the MTF data for different field angles across the image plane.

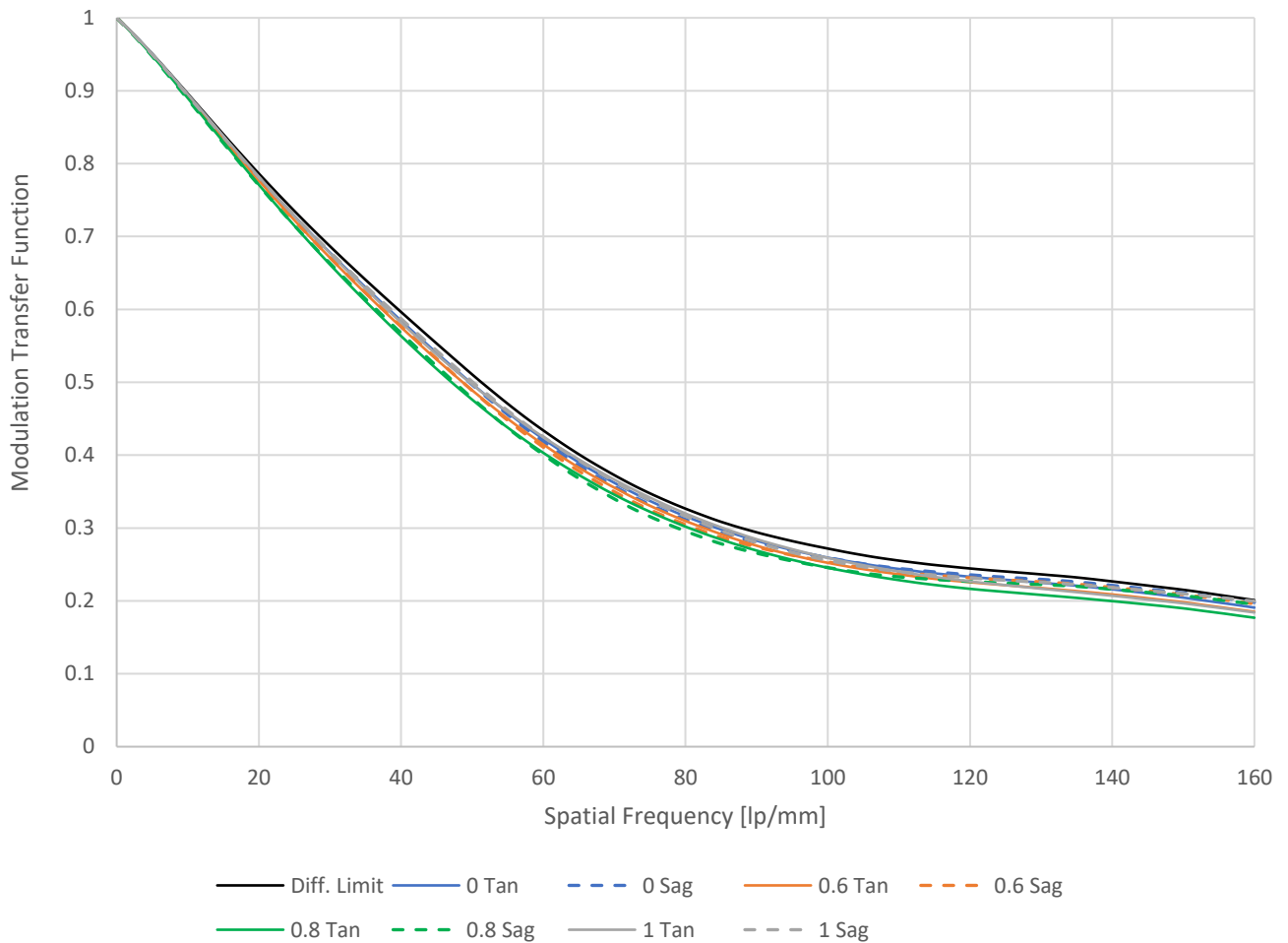

Figure 2-1: Polychromatic MTF as Function of Spatial Frequency at Different Field Angles

The data of Figure 2-1 is reproduced in Figure 2-2 where the polychromatic MTF is plotted against the relative field angle to indicate that the performance is maintained across the image plane at different spatial frequencies.

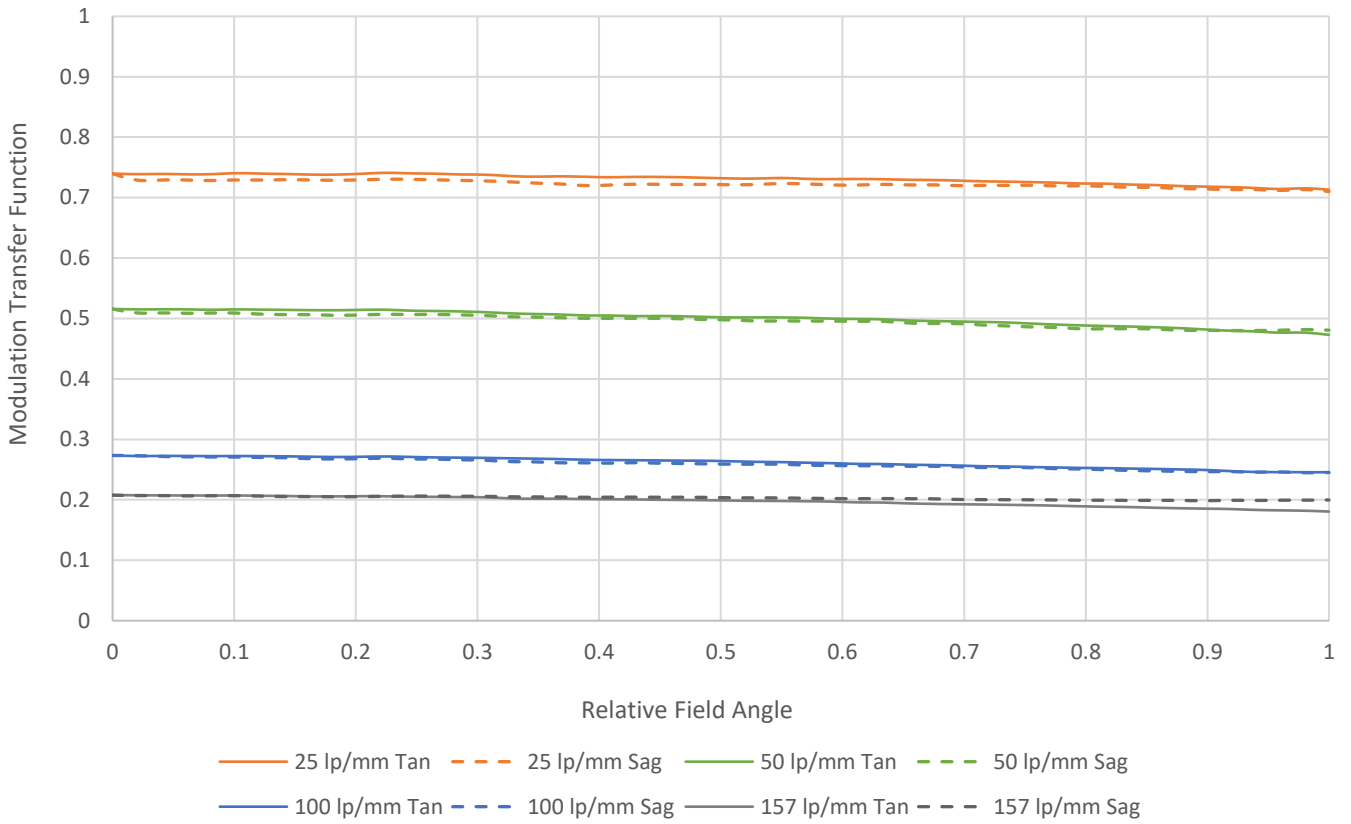

Figure 2-2: Polychromatic MTF Across Image Plane at Different Spatial Frequencies

2.2 Spectral MTF

The OFE is ideally suited to be used in multispectral and hyperspectral applications. This is illustrated in Figure 2-3 which shows the on-axis monochromatic performance of the system for various spectral bands.

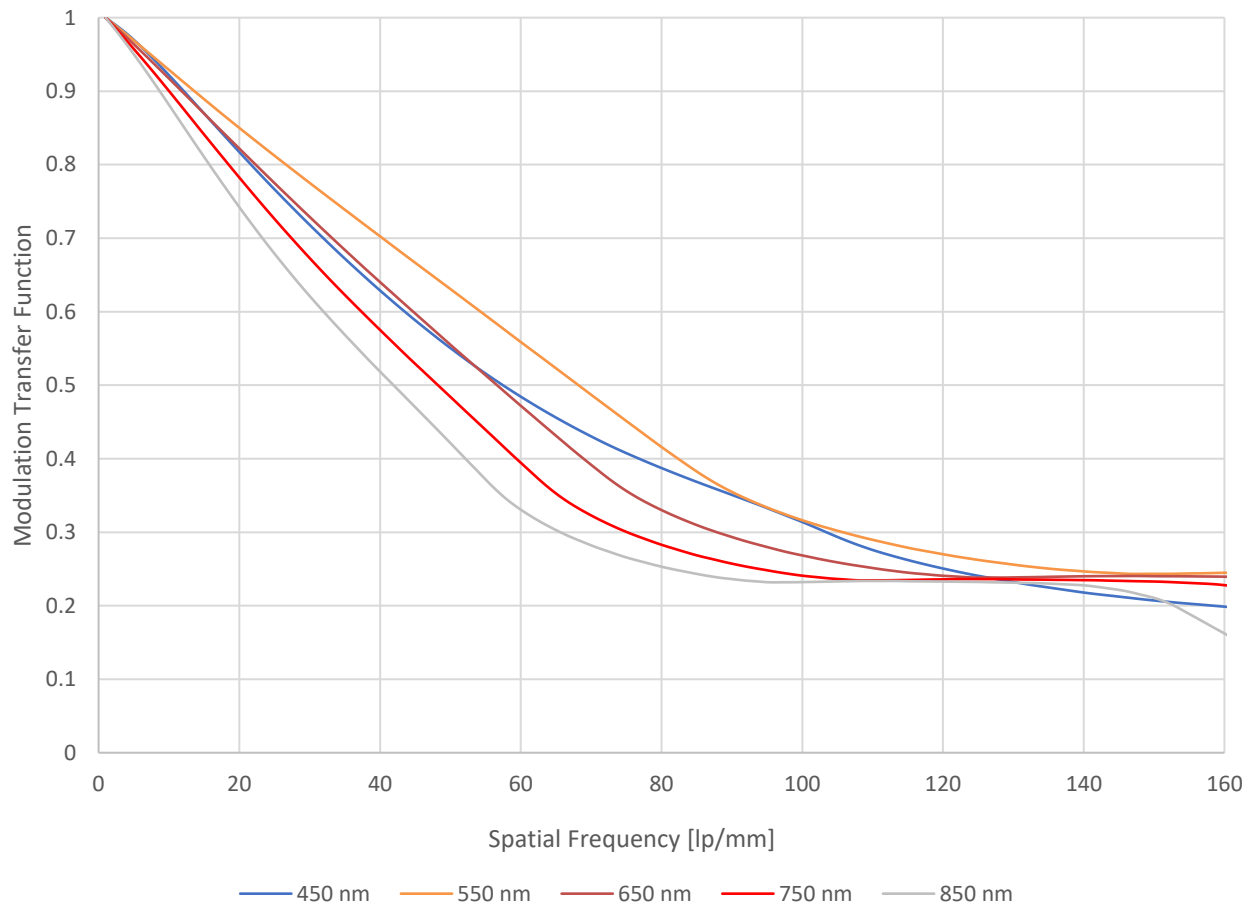

Figure 2-3: On-axis Monochromatic MTF as Function of Spatial Frequency

2.3 System Transmission

The transmission is given in Figure 2-4 where the effect of the obscuration on the transmission was considered.

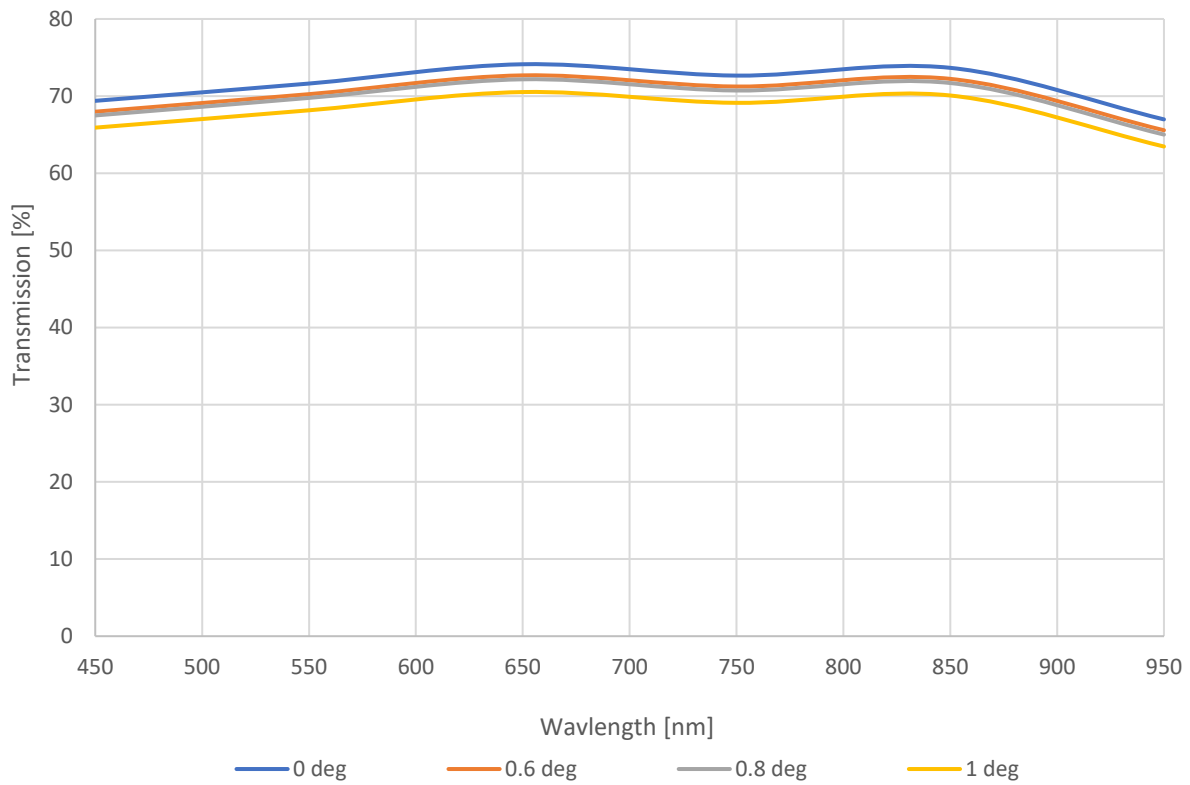

Figure 2-4: Transmission (Obscuration Considered) Across Spectral Range at Different Angles

2.4 Geometric Distortion

The geometric distortion, as a function of field angle, is given in Figure 2-5 for different wavelengths.

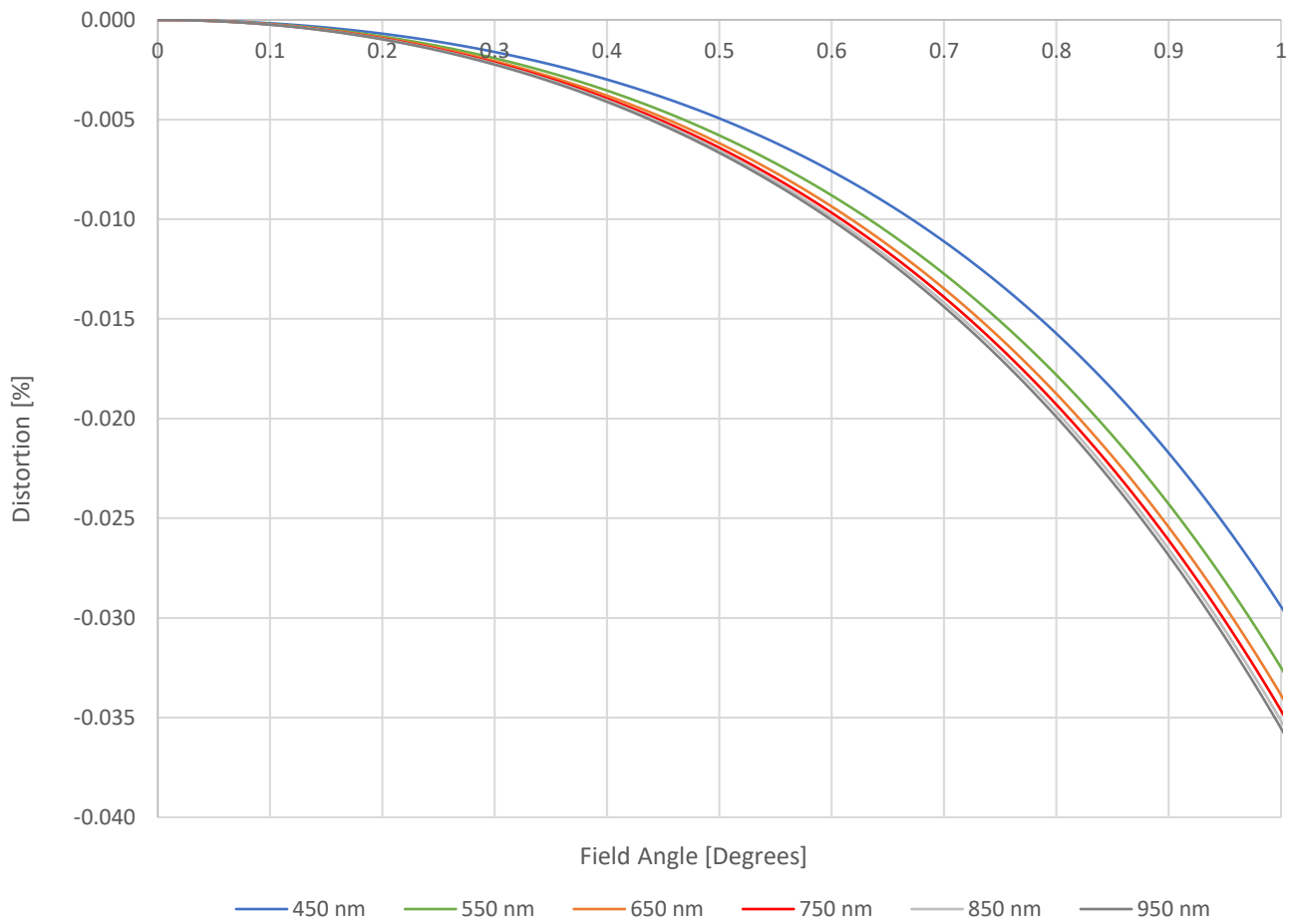

Figure 2-5: Distortion Across Image Plane at Different Wavelengths

2.5 Polychromatic (450 nm – 950 nm) Wavefront Error

The polychromatic root mean square (RMS) wavefront error of the system is given in Figure 2-6.

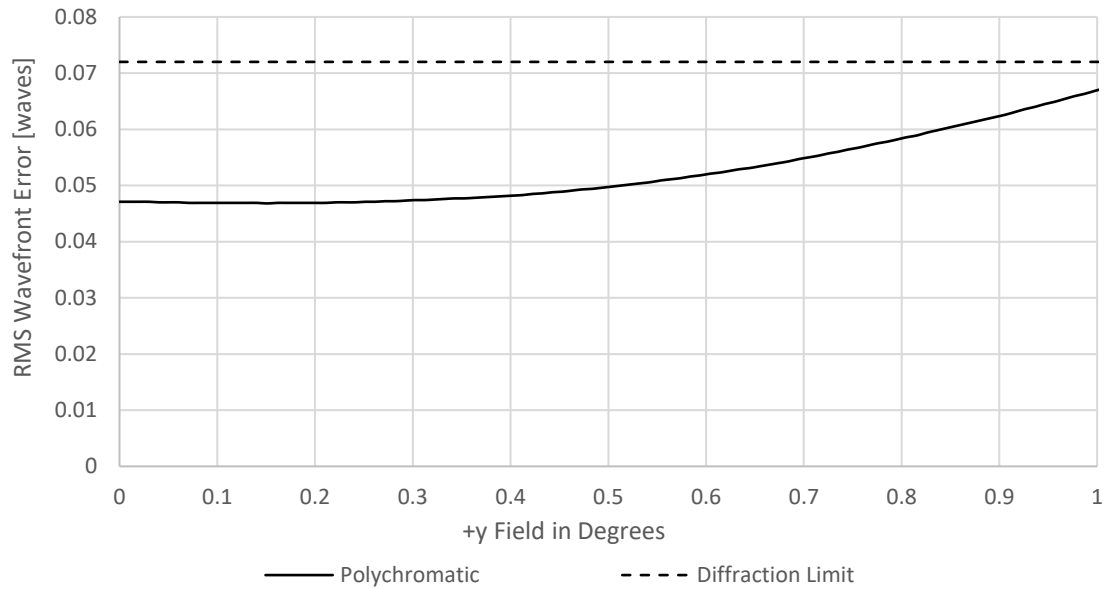

Figure 2-6: Polychromatic RMS Wavefront Error Across Image Plane

2.6 Relative Illumination

The system’s relative illumination for a uniform Lambertian scene is greater than 0.95 across the field as is shown in Figure 2-7.

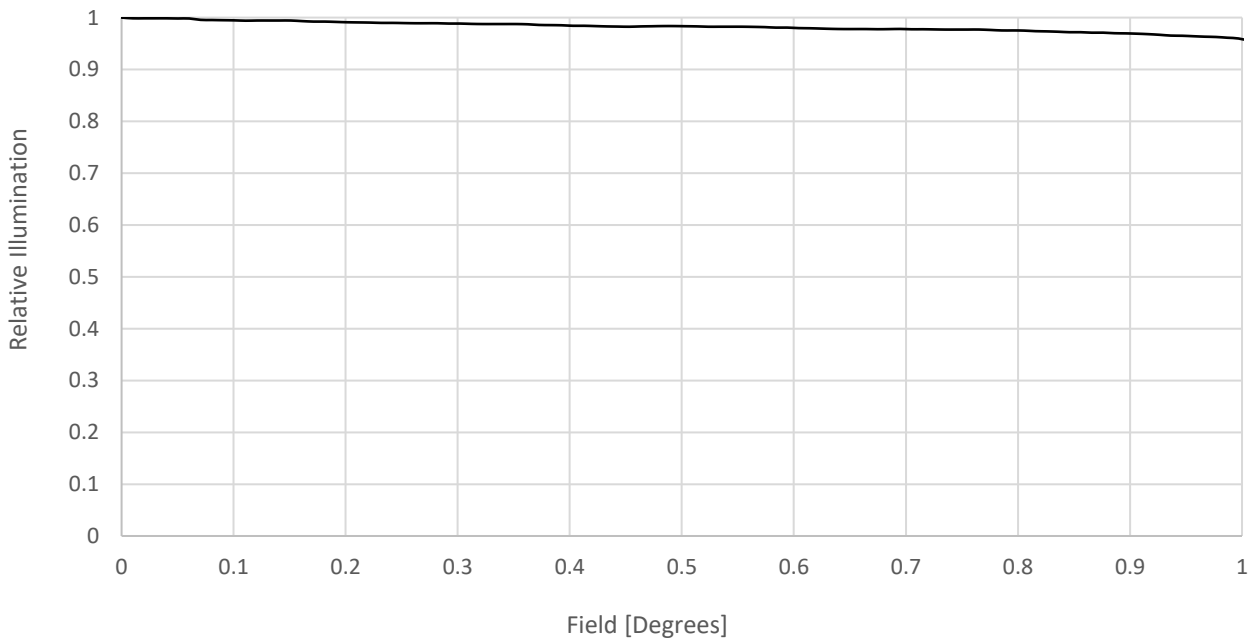

Figure 2-7: Relative Illumination Across Image Plane

3. Environmental Ratings

The xScape200 VNIR Optical Front-End is designed for use in low earth orbit space applications, within the environmental conditions described in Table 3-1.

Table 3-1: Environmental Absolute Maximum Ratings

Description	Value
Operating Temperature	-10 to +50 °C
Survivable Temperature	-25 to +65 °C
Vibration	14.1 g _{rms} (all directions) ²
Radiation	Naturally radiation resistant material has been selected for first optical element

² Based on GSFC-STD-7000

4. Physical Characteristics

The physical characteristics of the xScape200 VNIR Optical Front-End are shown in Table 4-1.

Table 4-1: Physical Characteristics

Description	Value
Mass	11.2 kg
Dimensions	200 x 200 x 284 mm

The mechanical layout and dimensions of the OFE are given in Figure 4-1.

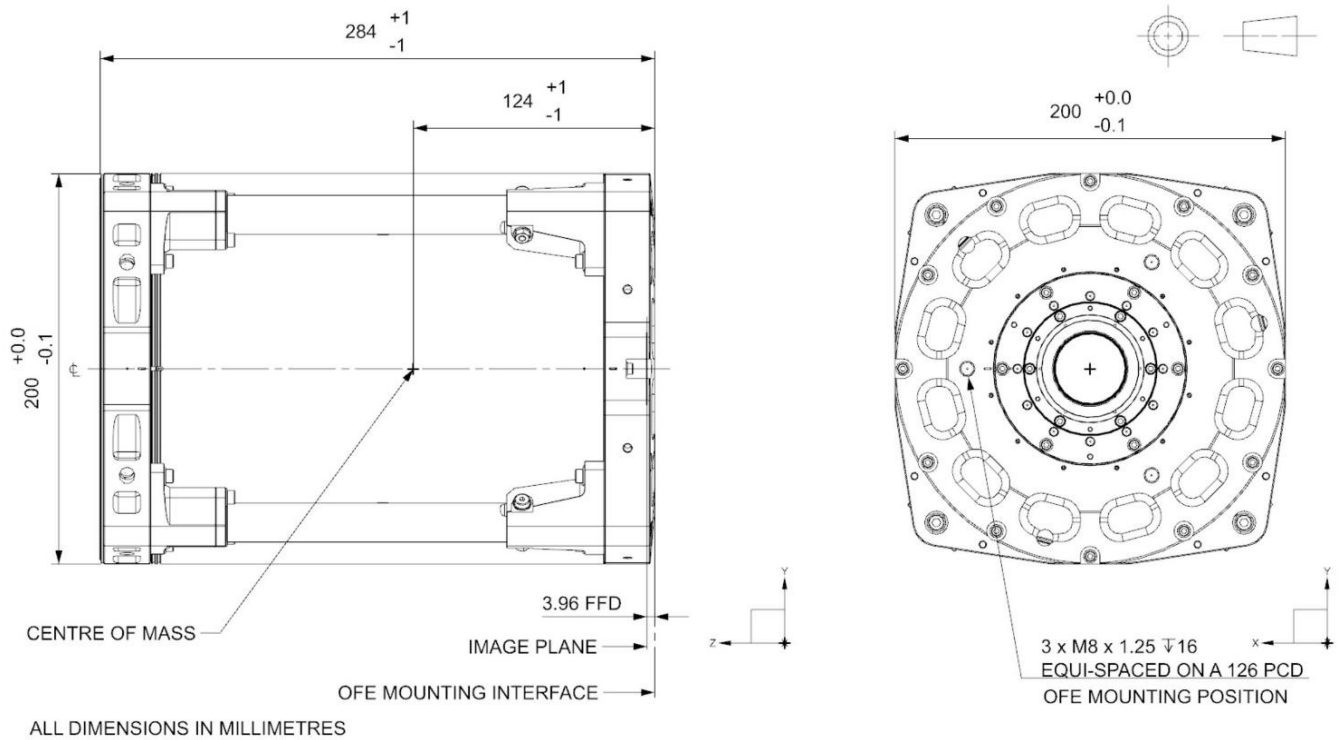

Figure 4-1: OFE Mechanical Layout and Dimensions

Contact Us

Simera Sense (Pty) Ltd

Old Paardevlei Road
Somerset West, 7130
South Africa
sense@simera.com